

SEQUENTIAL FAST KINETICS BY RELAXATION: APPLICATION IN CHEMISTRY AND BIOCHEMISTRY

Jacques-Emile Dubois

Institut de Topologie et de Dynamique des Systèmes (ITODYS)  
Université Paris VII, 1, rue Guy de la Brosse, 75005 PARIS, France.

Abstract - The dynamic aspects of certain chemical systems, whether they concern a chemical transformation or a physical evolution of fast phenomena, are at best achieved by relaxation techniques (notably by unique perturbation, such as T-jump or other influential property jumps). These are the best tools available for studying fast equilibrated reactions in solution. In this lecture, the efforts made to improve the rapidity limits and the precision of these complex relaxation methods will be presented in conjunction with two types of problems, chosen to prove the versatility of the automated instrumentation developed in the ITODYS. These problems deal with: a) conformational equilibria of polynucleotides in aqueous media and b) prototropic equilibria in solution, together with the detection and estimation of the proportions of the rare forms of the nucleotides whose existence is probably responsible for the degradation of genetic information.

After a brief reminder of the principle of relaxation techniques for sequential fast kinetics and its advantages for the study of equilibrium constants governed by fast exchanges, a survey is made of the principle and characteristics of an ultra-fast laser T-jump spectrophotometer.

Among the various improvements considered is the change of the I.R. frequency used to transfer heat to the water solvent and the synchronisation of a special detection with the laser flash to minimise the level of noise despite a high bandwidth. This system (7-8°C in 20 nanoseconds) is perfectly adapted to study conformational changes of oligonucleotides where the interconversion times for conformers are lower than 1  $\mu$ s.

A package of physical experimental improvements and original hardware interfacing a mini-computer allows us to accumulate a series of isolated T-jump classical experiments. (This interface corresponds to one 10 bit word every 2  $\mu$ s.) Thus are detected little known, or unknown, prototropic equilibria in water solutions of purine and pyrimidine of biological interest - notably, adenine and cytosine and their derivatives. A new mechanism for this prototropic interconversion is proposed. Natural anthocyanins have revealed numerous unknown reactions.

Large scale accumulation of small T-jumps, essential for the isolation of very rare forms, are considered.

INTRODUCTION

Over the last few years, our laboratory has devoted a part of its activity to studying the kinetics of proton transfers - notably intramolecular proton transfers (prototropic transformations). Since these reactions are generally too fast to be measured by classical kinetic techniques, we have been led to develop a major technological potential in fast kinetics, particularly in the field of chemical relaxation. At present, these techniques are so sensitive that they can be used not only as a kinetic tool (e.g. for studying the dynamics of tautomeric equilibria identified elsewhere), but even as an analytical tool; it is thus often possible to detect tautomeric equilibria in solution, even when they are very shifted, and estimate the corresponding thermodynamic parameters. Moreover, the time resolution has been improved in such a way that it is now possible to study the dynamics of certain conformational equilibria by single perturbation relaxation methods (transient relaxation methods).

In this lecture, I shall first briefly recall the underlying principle of single perturbation relaxation methods, notably that of T-Jump relaxation. This will be followed by a description of the performances obtained with the experimental assemblies in our laboratory, shown by a description of the results we have obtained using these techniques. This lecture will end with a glance at the perspectives which are presently open to us.

## PRINCIPLE OF TRANSIENT RELAXATION METHODS

Fast kinetic methods, notably chemical relaxation,<sup>1</sup> have developed over the last 15 years or so, at the same time as classical kinetic methods involving the previous mixture of reagents. These fast kinetic methods apply to equilibrated reactions, in which case the equilibrium constant is generally sensitive to a certain number of intensive variables ( $T$ ,  $P$ ,  $\vec{E}$ , etc...). Once equilibrium is established, if one of these intensive variables is abruptly perturbed, the system is then no longer in equilibrium and its composition tends to modify itself so as to adapt to the new thermodynamic conditions, as shown for a fast jump in temperature. (Fig. 1)

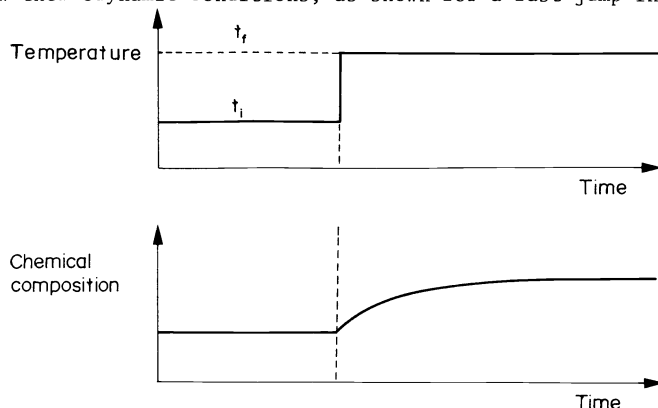

Fig. 1. Chemical relaxation principle (T-Jump)

The reequilibration kinetics is exponential if the perturbation of the equilibrium is not too large; the inverse of the time constant for this exponential is called the relaxation time ( $\tau$ ) of the system. Measuring this relaxation time yields information concerning the kinetic characteristics of the reaction studied.

I have decided to discuss herein the case where a chosen intensive variable is subjected to a single perturbation (transient relaxation methods). However, there is another method whereby a chosen intensive variable in a system is subjected to a periodic perturbation (stationary relaxation methods). When the variation period of the intensive variable reaches an order of magnitude the same as the relaxation time of the system, the composition of the system responds to the imposed perturbation with a certain delay; this is expressed by an absorption of energy. Thus, the relaxation time of the system can be estimated in this way from the energy dissipation curves as a function of the variation time period of the chosen intensive variable. The best known stationary relaxation method is ultrasonic absorption whereby the ultrasounds passing through the solution make the pressure and the temperature vary periodically at each point. The main drawback of these methods lies in the difficulty involved in attributing the observed relaxations to a given equilibrium since it is not the modifications in concentration of a definite species which are measured directly, but only an overall phenomenon (the energy dissipation). Nevertheless, up till now, these methods have been irreplaceable as they allow one to measure extremely fast processes (between  $10^{-5}$  and  $10^{-10}$ s). Yet, the rapid development in performance of single perturbation methods, whose results are much easier to interpret, should make the stationary methods less interesting. Thus, in the part that follows, only transient relaxation methods, notably T-Jump which is the most important one, will be dealt with.

Figure 2 shows the performance of the major relaxation methods currently cited in literature.

Method	time resolution	main limitation
<u>Extension of classical methods</u>		
stopped-flow	$> 10^{-3}$ s	"slow" method
<u>Transient relaxation methods</u>		
T-Jump [ Joule heating ]	$> 10^{-5}$ to $10^{-6}$ s	requires using conducting solutions
P-Jump	$> 10^{-4}$ s	
E-Jump	$> 10^{-8}$ s	limited to ion dissociation reactions
<u>Stationary relaxation methods</u>		
ultrasonic absorption	$10^{-5} > \tau > 10^{-10}$ s	difficulty in attributing the observed phenomena.

Fig. 2. Main available fast kinetic methods

It should particularly be noted that:

- transient relaxation methods are of interest only as far as one makes the chosen intensive variable (T in this case) vary more quickly than the reagents can be mixed (essentially with stopped-flow techniques);
- the rate of modification of the intensive variable should be markedly greater than the reequilibration rate of the studied chemical system;
- since the perturbation to which the equilibrium is subjected is generally small (this is a theoretical obligation, otherwise the reequilibration is not exponential; it is often a technological necessity also), the variations in chemical composition to be observed are also rather small.

These aspects define the objectives and ways necessary to consider and improve the transient relaxation methods:

- pushing back the lower limit of the accessible relaxation times, in other words, decreasing the duration of the perturbations and increasing the rapidity of the detections in order to match as nearly as possible the performances achieved by stationary relaxation techniques (e.g. ultrasonic absorption) where the results are often hard to interpret. (We shall describe the improvements in this area made in our laboratory for the T-Jump technique).
- increasing the sensitivity of signal acquisition techniques in order to extend them to the detection and dynamic study of highly shifted equilibria (We shall deal only with spectrophotometric devices built and improved in our laboratory).

### LASER T-JUMP: PRINCIPLE AND APPLICATIONS<sup>2,3</sup>

#### Heating

In the device shown in Figure 3, the medium is abruptly heated by the absorption of an infrared laser energy pulse from a large switched mode laser. This is heating by vibrational relaxation of the solvent molecules. Since the switched mode lasers can provide pulses lasting several tens of ns, one can hope thereby to obtain heating lasting just as long.

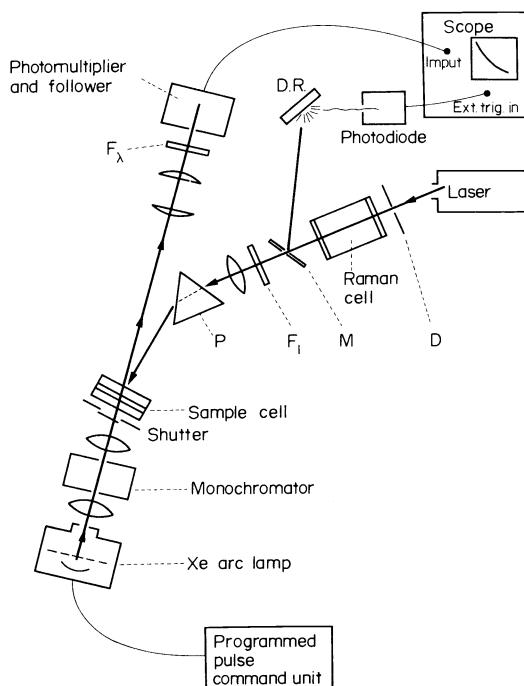

Fig. 3. Laser T-Jump: Schematic diagram

Unfortunately, there is no switched mode laser providing enough energy (several joules) in a zone where water (the solvent we most often use) has a marked extinction coefficient. In order to surmount this difficulty, we use the radiation of a neodymium switched laser whose frequency is modified by stimulated Raman effect in liquid nitrogen (Fig. 3). The laser output (20 J in about 30 ns) is thus transformed; the yield is about 15% and the wavelength shifts from 1.06 to 1.41  $\mu$ , a wavelength where water absorbs strongly. It is thus possible to carry out heating of about 3-7°C for 0.2 to 1 mm optical path cells in about 20 ns.

#### Detection

Having an extremely fast heating available is of interest only if one can detect very fast variations in composition which follow this heating: when this detection is carried out by spectrophotometry, a very high bandwidth ( $\Delta f$ ) is required. The signal-to-noise ratio (S/N) for such a detection is given by the following formula<sup>1a</sup> (Fig. 4):

$$S/N = (\eta I_p / 2e\Delta f)^{1/2}$$

$\Delta f$  : detection bandwidth

$e$  : electron charge

$\eta$  : quantum efficiency of the photocathode

$I_p$  : photocurrent

Fig. 4. Signal-to-noise (S/N) ratio (Spectrophotometric detection)

An increase in  $\Delta f$  degrades the S/N ratio and the relaxation signals quickly become inobservable, unless the photocurrent ( $I_p$ ) can be increased at the same time. This is exactly what we do by pulsing the analysis lamp<sup>2</sup> for a few ms so as to coincide with the starting of the pumping flashlamp of the laser; its brilliance (and thereby  $I_p$ ) is multiplied by a factor of 100 to 1000 during this time interval - thereby corresponding to an increase in the S/N ratio by a factor of 10 to 30.

Pulsed in this manner, the detection has a noise level in the UV of about  $10^{-3}$  O.D. units, for a rise time of about 10 ns. In all, the entire equipment has a spectral sensitivity comparable to that of classical Joule effect apparatuses for a time resolution that is about 500 times better.

#### Some applications

The above-described apparatus was first developed in order to study very fast prototropic transformations in aqueous solution. For example, uracil with a pH above 9.5 exists in solution in the form of a mixture of tautomeric anions (Fig. 5). The interconversion of these two species is always very fast ( $100 \text{ ns} < \tau < 3 \mu\text{s}$ ) depending on the pH and the concentration.

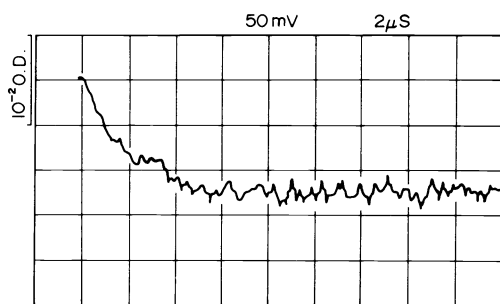
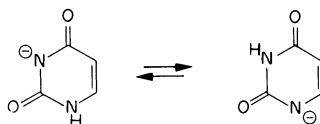

Fig. 5. Laser T-Jump relaxation uracil anions (3mM)

The interconversion process is still easily observable by the T-Jump laser technique. The variation of  $\tau$  with the pH and the concentration has allowed us to elucidate completely the tautomeric interconversion mechanism in this particular case.

Moreover, the performances achieved by our equipment have permitted the direct study of certain major conformational equilibria.<sup>3</sup> For example, 3'-5' dinucleosides are the simplest molecules already having the sugar-phosphate-sugar chain characteristic of nucleic acid skeletons. A study of the dynamics of the conformational equilibria in this system allows one to obtain information about the forces which insure the stability of the stacked structures in single coil of single-stranded DNA and RNA molecules. Since the stacked  $\rightleftharpoons$  unstacked transition is accompanied by a variation in the molecular excitation coefficient, its kinetics can be studied with our equipment. The result is shown in Figure 6 for adenosyl

3'-5' adenosine (ApA).

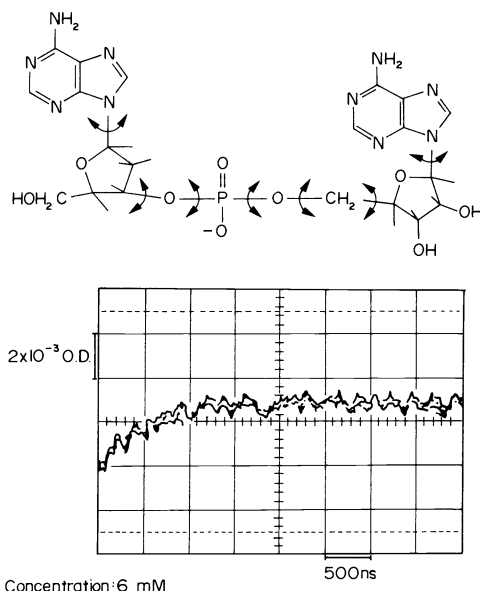

Fig. 6. Laser T-Jump: relaxation ApA stacked  $\rightleftharpoons$  unstacked

It can be seen that the conformational interconversion occurs at a rate that falls within the time range accessible to the laser T-Jump apparatus. The relative "slowness" of the conformational interconversion in this system is undoubtedly due to the large number of degrees of freedom brought into play (strong activation entropy).

INCREASING THE SENSITIVITY OF THE JOULE-HEATED T-JUMP SPECTROPHOTOMETER

Equipment

Up to this point I have dealt with our efforts to push back the lower limits of the half-life reactions accessible with transient T-Jump relaxation techniques. I shall now deal with the improvements we have brought to commercial spectrophotometers, notably to the classical Joule effect T-Jump apparatus. These improvements fall into two categories:

- better control of experimental parameters, notably pH and temperature, which can now be measured continuously during experiments with  $\pm 0.02$  and  $\pm 0.2^\circ\text{C}$  precision, respectively (even in a neutral non-buffered medium);
- computer handling of signals. Instead of attacking an oscilloscope whose trace is then photographed and analyzed, the analogical signal delivered by the T-Jump apparatus is digitalized in an interface and stored for handling in the memory of a small computer (PDP 11/10) (Fig. 7).

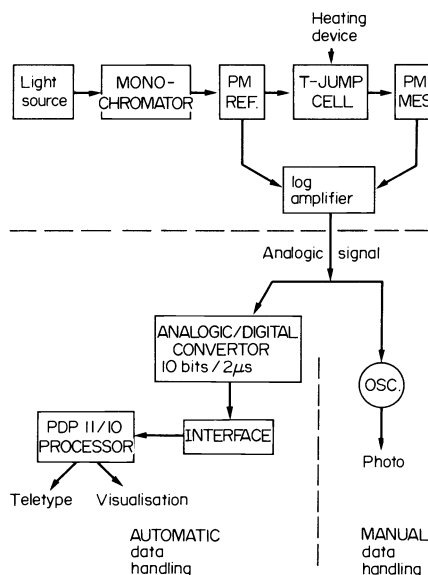

Fig. 7. Principle of a T-Jump spectrometer interfaced to a small computer

This not only allows the objective and rapid processing of the data provided by the apparatus, but leads to an improvement of the S/N ratio by accumulating identical signals. I shall develop this point further on.

Three types of numerical acquisition can be envisaged a priori, depending on the rapidity in variation of the analogical signal studied (Fig. 8).

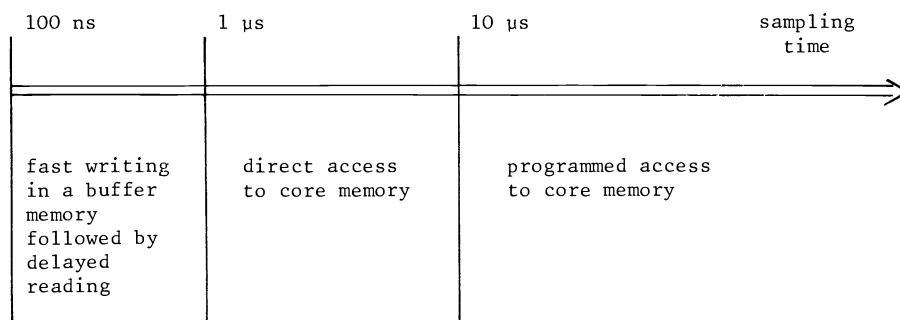

Fig. 8. Acquisition techniques as a function of relaxation times

Given the rather slow heating times of these techniques (a few  $\mu$ s), only kinetics with relaxation times  $\geq 10 \mu$ s can be studied with precision. Consequently, the most suitable sampling technique is direct access to core memory with a sampling time of about 1  $\mu$ s. We use an interface, built in our laboratory, which permits sampling the T-Jump output, i.e. acquiring one 10 bit word every 2  $\mu$ s. The type of results obtained with this sampling technique are summarized in Figure 9 (the studied relaxation is the reequilibration of a tautomeric equilibrium of adenine):

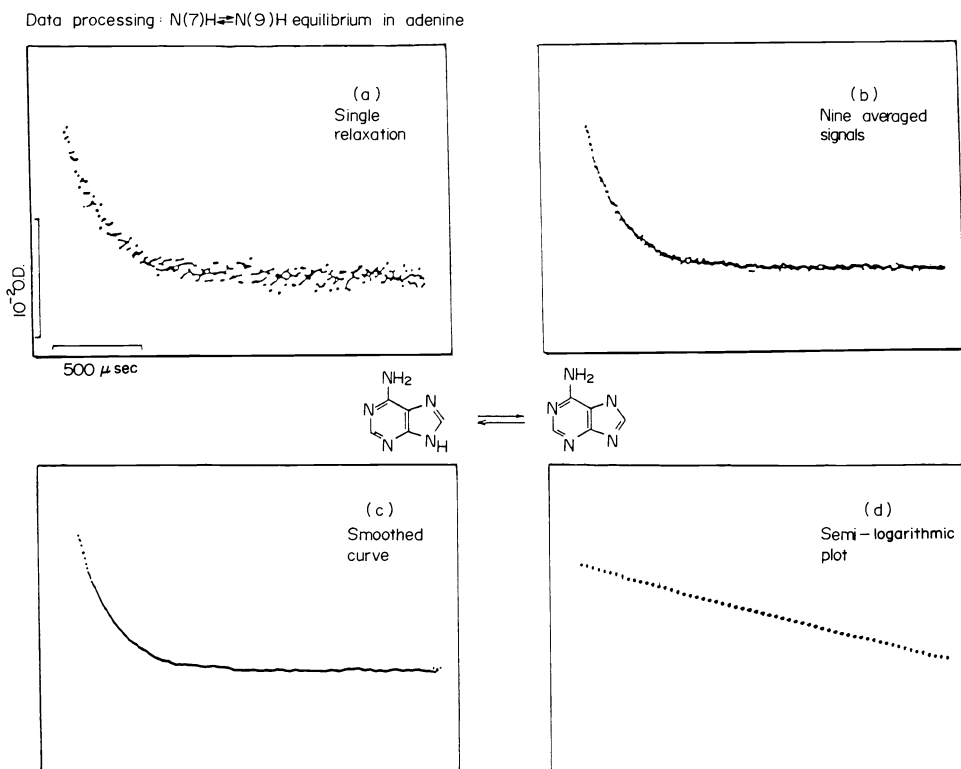

Fig. 9. Data processing: N(7)H  $\rightleftharpoons$  N(9)H equilibrium in adenine

The relaxation time ( $\tau$ ) of the system is extracted from the straight line in Figure 9. Extrapolation of the straight line at zero time gives the amplitude (A) of the relaxation. The reproducibility of the runs is such that with average amplitude signals (as in Figure 9), A and  $\tau$  can be measured with a standard deviation of about 5%; this is a considerable improvement over manual handling.

In our laboratory, this technique has been used mostly to study the thermodynamics and kinetics of prototropic interconversions for heterocyclic structures. I shall briefly evoke the principle of these studies, followed by some results we have obtained.

Application to the thermodynamics and kinetics of prototropic equilibria in aqueous solution. We shall represent the two interconverting tautomeric species by HX and XH (I shall suppose that  $K = [XH] / [HX] < 1$ ). If, in each structure, the labile proton is attached to a hetero-atom, then the interconversion is always "fast" in comparison to that obtained by classical kinetic methods. Even the equilibrium constant is hard to estimate if it is below 0.1, because the spectroscopic techniques for studying this type of tautomeric equilibria lack precision.

If the tautomeric mixture  $HX \rightleftharpoons XH$  is subjected to a temperature jump and if the variations in the composition of the medium are followed spectrophotometrically, it can be shown that the deviation between the optical density and its final value  $\Delta(O.D.)$  is expressed as follows (Fig. 10):

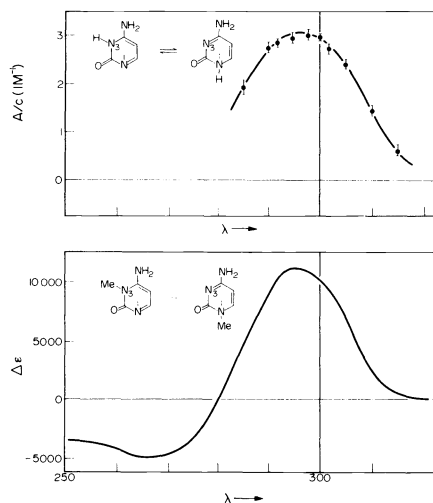
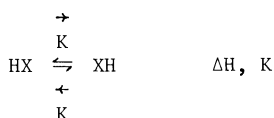

Fig. 10. Expression of relaxation time and amplitude for a tautomeric equilibrium

It can be seen from these expressions that:

- measuring the relaxation time ( $\tau^{-1}$ ) gives the sum of the direct and inverse rate constants of the tautomeric equilibrium;
- the amplitude, A, is independent of the pH and is proportional to the concentration; moreover, all things being equal elsewhere, it is proportional to the difference between the spectra of the exchanging species. Since these spectra differ little from those of the blocked derivatives in which the labile proton has been replaced by a methyl group, we have here a means of attributing the observed relaxation to a given tautomeric equilibrium. For example, with cytosine solutions, we observe a relaxation phenomenon whose amplitude is independent of the pH and which is proportional to the concentration. The comparison of the wavelength dependence of the amplitude with the UV spectra of various methylated cytosine derivatives allows the attribution of the observed relaxation to the  $N(1)H \rightleftharpoons N(3)H$  equilibrium of cytosine (Fig. 11).
- the amplitude depends on the thermodynamic parameters of the system. If  $K \ll 1$ , one can write:

$$(A\tau^2) = (\text{known constant}) \cdot \Delta H \cdot K$$



$$\Delta(\text{O.D.}) = A e^{-t/\tau}$$

with :

$$\tau^{-1} = (\vec{K} + \overleftarrow{K})$$

$$A = \frac{\Delta H}{RT^2} \cdot \frac{KC}{(1+K)^2} l \delta T (\epsilon_{\text{XH}} - \epsilon_{\text{HX}})_{\gamma}$$

where :

C is the total concentration (HX + XH)

l, the optical length

$\delta T$ , magnitude of the temperature rise

$\epsilon_{\text{XH}}$ ,  $\epsilon_{\text{HX}}$ , molar extinction coefficients.

Fig. 11. Cytosine: attribution of relaxation

Measuring the product ( $A \cdot T^2$ ) as a function of the temperature (for a given  $\delta T$ ) will thus allow estimating  $\Delta H$  and  $K$ . For example, in the case of the equilibrium  $\text{N}(1)\text{H} \rightleftharpoons \text{N}(3)\text{H}$  in cytosine, the variation of  $\ln(AT^2)$  as a function of  $1/T$  is a straight line, whose slope gives  $\Delta H = 3.1 \text{ Kcal M}^{-1}$  (Fig. 12). Using this value in the expression of the amplitude at  $25^\circ\text{C}$  gives:

$$K = \frac{\text{N}(3)\text{H}}{\text{N}(1)\text{H}} \approx \frac{1}{400} \text{ at } 25^\circ\text{C}$$

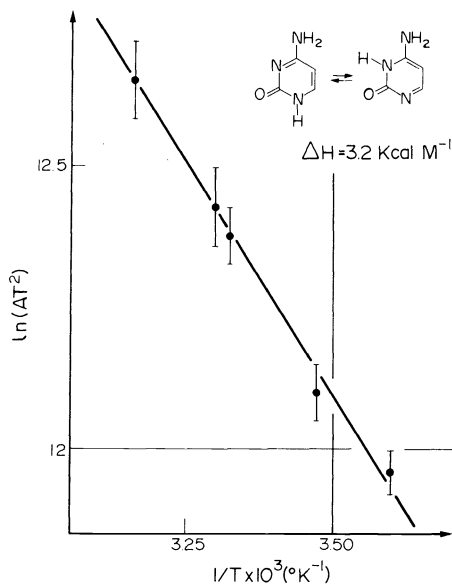

Fig. 12. Cytosine : variation of relaxation amplitude with temperature

It is clear from this example that even very shifted equilibria can be studied by this chemical relaxation technique. This extremely sensitive technique has permitted detecting little known, or unknown, prototropic equilibria in solutions of purines and pyrimidines of biological interest; in all cases it has been possible to determine the abundance of the different forms and their rate of interconversion.<sup>4</sup> Some of the most outstanding thermodynamic results are shown in Figure 13.



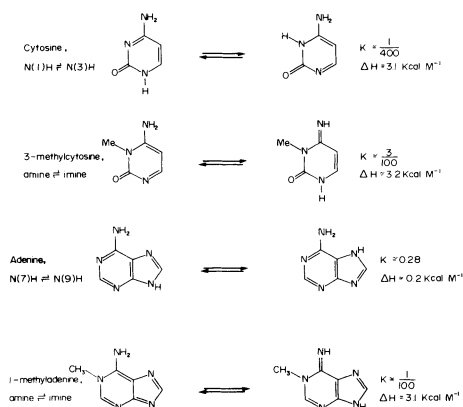

Fig. 13. Thermodynamic results on some nucleic acid derivatives

The interest of this type of information is evident. For example, comparison of the first two equilibrium constants in Figure 13 allows one to estimate the amine  $\rightleftharpoons$  imine equilibrium constant of 1-substituted cytosines (Fig. 14).

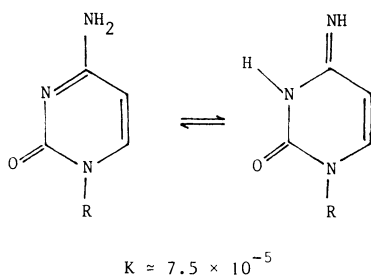

Fig. 14. Cytosine : Amine-Imine tautomerism

It should be recalled that determining the abundance of this rare imine form, which is liable to lead to mispairing during DNA replication, is particularly important in Watson and Crick's classical theory of mutagenesis.

#### General mechanism of tautomeric interconversion in these systems

As of now we have studied the reequilibration kinetics of more than 20 prototropic systems of this type.<sup>5</sup> In all cases, the reequilibration rate law has been examined as a function of the pH and of the substrate concentration. The overall results, with the exception of the particular case of  $\alpha$ -substituted pyridines mentioned above, can be interpreted on the basis of the two following hypotheses:

- a) The interconversion always occurs via the ionized anion or cation forms common to both tautomers (Fig. 15). The tautomeric interconversion is thus acid and base catalyzed, just like the tautomeric interconversion of "slow" systems, causing the making or breaking of a -CH bond (cf. keto-enol interconversion).

#### Acid catalysis

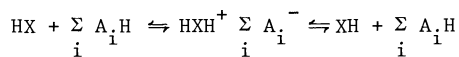

#### Base catalysis

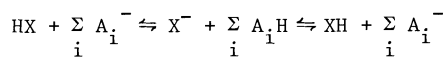

Fig. 15. Mechanism of tautomeric interconversion - 2 steps mechanisms

- b) The thermodynamically favorable proton transfer reactions, in these processes, have a very high rate constant which is close to the foreseen limit for the diffusion of the reagents. The usually observed orders of magnitude are shown in Figure 16.

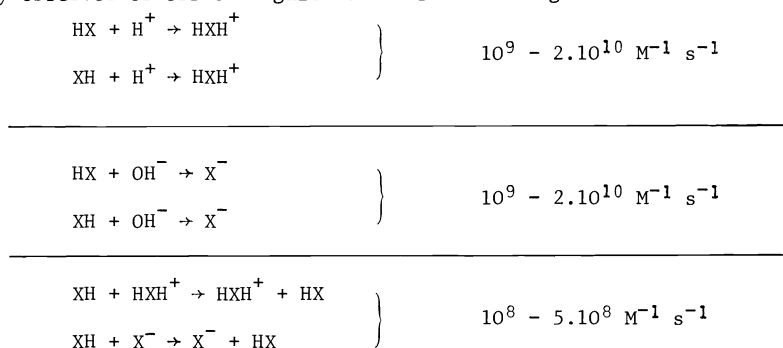

Fig. 16. Proton transfer reactions : observed range

These two hypotheses are generally sufficient to explain the observed kinetics. In particular, in a very diluted solution, catalysis by  $\text{H}^+$  and by  $\text{OH}^-$  ( $\approx 10^{10} \text{ M}^{-1} \text{ s}^{-1}$ ) is sufficient to account for very high rate constants observed even in a neutral medium, where  $[\text{H}^+] \approx [\text{OH}^-] = 10^{-7} \text{ M}$ ; the relaxation time is indeed written as:

$$\tau^{-1} \approx 10^{10} [\text{H}^+] + 10^{10} [\text{OH}^-]$$

in other words,  $\tau^{-1} > 10^3 \text{ s}^{-1}$  even at  $\text{pH} = 7$ .

It can be seen that the half-life of the tautomeric interconversion is always less than 1 ms, i.e. always outside the reach of "classical" kinetic techniques. As an example of this type of "normal" kinetic behavior, we have shown (Fig. 17) the variation of  $\tau^{-1}$  as a function of the pH for the  $\text{N}(7)\text{H} \rightleftharpoons \text{N}(9)\text{H}$  equilibrium which occurs in aqueous solutions of adenine.

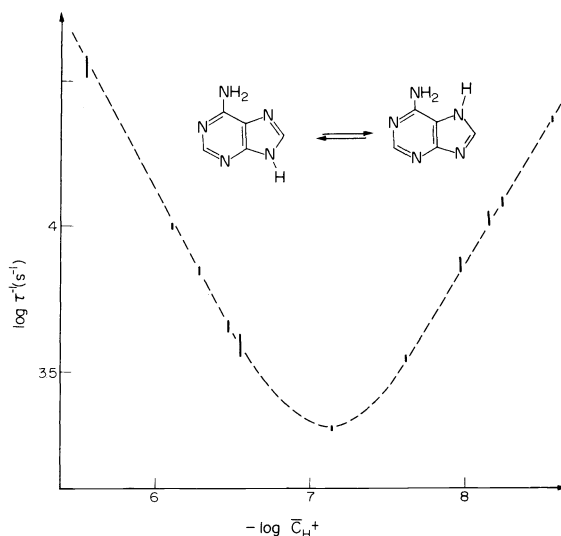

Fig. 17. Adenine (0.7mM):  $\text{N}(7)\text{H} \rightleftharpoons \text{N}(9)\text{H}$  kinetic results

However, in a certain number of cases (notably  $\alpha$ -substituted pyridines), we observe that this simple interconversion mechanism (which has 2 steps via the ionized forms common to both tautomers) does not account for the results. More specifically, the rate law has a term which is independent of pH and which is much larger than the one expected from the catalytic efficiency of the water acting as an acid or as a base. This is illustrated in Fig. 18 where the continuous line represents the experimental curve, and where the dashed line represents the expected curve when supposing an exclusive interconversion mechanism via the ionized forms of the substrate.

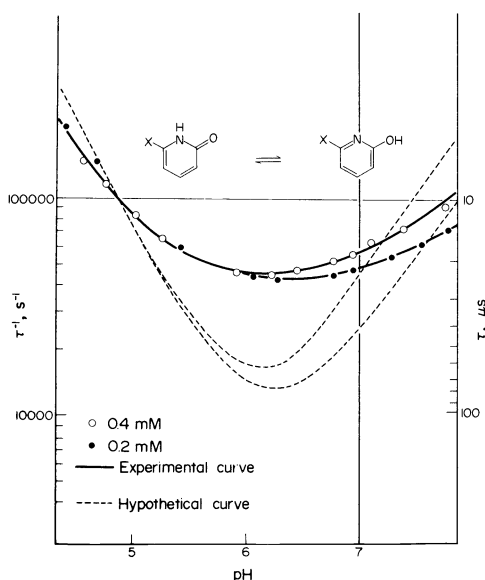

Fig. 18. Tautomeric interconversion kinetics of 6-chloro-2-pyridone

In this case where the proton donor and acceptor sites are very close, one must admit that the labile proton can oscillate from one site to the other, according to a concerted mechanism, without an intermediate ionic dissociation. This is represented in Figure 19 where the geometric requirements for the observation of such a mechanism are illustrated.

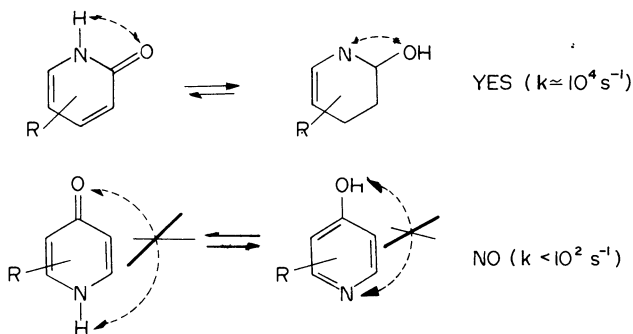

Fig. 19. Non-dissociative proton-transfer mechanism

There is little doubt that such a concerted proton transfer mechanism brings into play the acid-base bifunctional catalyst properties of the water solvent. We are currently carrying out a more specific study on the role played by water in this process.

#### CONCLUSION

The success of our fast kinetic techniques in the detection and study of prototropic equilibria, even when very shifted, in aqueous solution, is prompting us to continue our efforts in this direction. We are currently trying to increase the sensitivity of the method even further by using a new mode of temperature perturbation capable of reaching a much higher frequency of repetition than the Joule effect T-Jump apparatus. Right now we are testing the performance of a magnetron (microwave heating), capable of heating a few  $\mu\text{l}$  of water with a frequency of 50 Hz. With this very high repetition rate, which allows very important signal accumulations (e.g., 10 000 runs with  $\delta T = 1.5^\circ\text{C}$ ), the spectral sensitivity of the equipment is much better than that obtained with the classical experimental assembly with Joule effect heating. The performances of the different T-Jump techniques either existing or being developed in our laboratory are shown in Figure 20.

Technique	Heating time	Magnitude of T-Jump	Spectral sensitivity (with accumulation)
Joule heating	1-5 $\mu$ s	3-10°C	5.10 <sup>-4</sup> O.D. units
Laser	20 ns	3-7°C	1. 10 <sup>-3</sup> O.D. units
Microwave	250ns -1.2 $\mu$ s	0.3-1.5°C	5.10 <sup>-5</sup> O.D. units

Fig. 20. Performances of the T-Jump techniques

Acknowledgement - I wish to take this opportunity to evoke here the names of all those at the Laboratoire de Chimie Organique Physique who have contributed to the advance of chemical relaxation techniques and uses, particularly in the area of labile protons: the late P. Alcais, J. Aubard, O. Bensaude, R. Brouillard, B. Delaporte, G. Dodin, M. Dreyfus and J.J. Meyer.

#### REFERENCES

1. For a general review on both theory and practice of chemical relaxation see: a) M. Eigen and L. De Maeyer, "Technique of organic chemistry" 8 (2) Interscience, New York (1963) and b) C.F. Bernasconi, "Relaxation Kinetics" Academic Press, New York (1976).
2. J. Aubard, J.J. Meyer and J.E. Dubois, Chem.Inst. 8, 1-16 (1977).
3. J.J. Meyer and J. Aubard, Rev.Sci.Inst. 48, 695 (1977).
4. For a detailed report of this work, see a) M. Dreyfus, G. Dodin, O. Bensaude and J.E. Dubois, J.Am.Chem.Soc. 97, 2369-2376 (1975); b) ibid, 99 (in press) 1977; c) M. Dreyfus, O. Bensaude, G. Dodin and J.E. Dubois, ibid, 98, 6338-6349 (1976); d) G. Dodin, M. Dreyfus, O. Bensaude and J.E. Dubois, 99 (in press) (1977).
5. O. Bensaude, M. Dreyfus, G. Dodin and J.E. Dubois, J.Am.Chem.Soc. 99, 4438-4446 (1977).

#### other contributions

- P. Alcais et R. Brouillard, J.C.S. Perkin II, 1214-1219 (1972).  
 R. Brouillard et J.E. Dubois, J.of Org.Chem. 39, 1137-1142 (1974).  
 R. Brouillard and J.E. Dubois, J.Am.Chem.Soc. 99, 1359-1364 (1977).